

uniden®

SPU554KTS Trunked/Conventional FM Transceiver

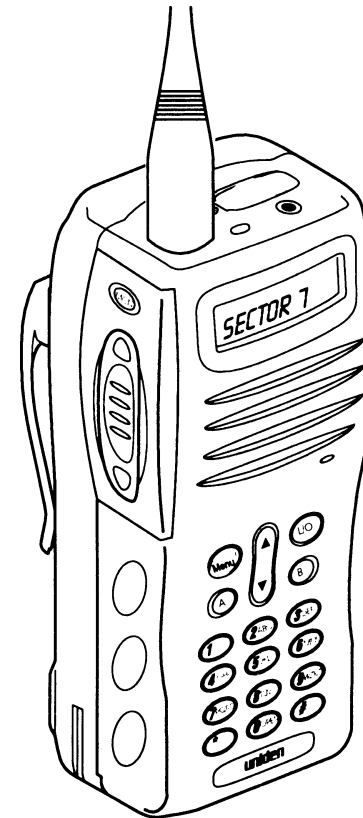

RELM

WIRELESS CORPORATION

7100 Technology Drive
West Melbourne, FL 32904

©2000 RELM Wireless Corporation. All Rights Reserved

OMSPU554KTS

RELM WIRELESS CORPORATION
7100 Technology Drive
West Melbourne, FL 32904

Operating Guide

OMSPU554KTS

Safety Information

Through the provisions of the Occupational Safety and Health Act (OSHA) of 1970, the United States Department of Labor has established an electromagnetic safety standard which applies to the use of two-way radio equipment. The proper use of this transceiver will result in exposure below the OSHA limit.

The following precautions shall be observed:

- **DO NOT** operate the transceiver of any radio equipment with the antenna touching, or close to, the eyes, faces, or exposed body parts.
- **DO NOT** operate the transmitter of any radio equipment unless all the Radio Frequency (RF) connectors are secure and any open connectors are properly terminated.
- **DO NOT** operate the transmitter of any radio equipment near electrical blasting caps or in an explosive environment.
- **DO NOT** let children operate any transmitter-equipped radio equipment.
- Have your radio equipment installed and service by a qualified technician

Rechargeable Nickel-Cadmium Battery Pack Warning

This radio contains a Rechargeable Nickel-Cadmium Battery Pack. Cadmium is a chemical known to the State of California to cause cancer. The Rechargeable Nickel-Cadmium Battery Pack contained in this radio may explode if disposed of in a fire.

DO NOT short circuit this Rechargeable Nickel-Cadmium Battery Pack.

DO NOT charge the Rechargeable Nickel-Cadmium Battery Pack except with the recommended chargers .

Rechargeable Nickel-Cadmium Battery Packs Must Be Recycled or Disposed of Properly!

Residents of Minnesota should contact 1-800-225-PRBA for information concerning reclamation and disposal of Rechargeable Nickel-Cadmium Battery Packs. Residents outside of Minnesota should contact their local authorities for information concerning reclamation and disposal of Rechargeable Nickel-Cadmium Battery Packs.

Caution: RELM does not represent this radio to be waterproof Do not use the radio in damp or high-moisture environments.

Two year Limited Warranty

WARRANTOR: RELM Wireless Corporation (“RELM” or “Warrantor”).

ELEMENTS OF WARRANTY: RELM Wireless Corporation warrants to the purchaser that all new Radio equipment of RELM’s manufacture shall be free of defects in material and workmanship. Equipment and accessory items not manufactured by RELM carry the standard warranty of the manufacturer thereof.

WARRANTY DURATION: The warranty period for all parts is two (2) years. The warranty period shall commence upon installation of the equipment or two (2) months from the date of shipment from the factory, whichever comes first.

The warranty shall terminate and be of no further effect two (2) years from its origin or at the time the Product is (a) damaged or not maintained as reasonable, (b) modified, (c) improperly installed, (d) is repaired by someone other than Warrantor or Authorized Warranty Repair Station for a defect or malfunction covered by this Warranty, or (e) used in a manner or purpose for which the Product was not intended or in an environmental condition for which the Product was not intended.

STATEMENT OF REMEDY: Where permitted by law, this Warranty is in lieu of all other Warranties expressed or implied, including warranties of merchantability or fitness for a particular purpose, and no representative or person is authorized to assume for us any other liability. This warranty shall not extend to incidental or consequential damages arising from operation of Product(s) which are subject of this Warranty. Some States do not allow limitation of implied warranties so the above limitations may not be applicable. You may have rights as defined by individual State law.

WARRANTY REGISTRATION CARD: In order to facilitate the service under this Warranty, Purchaser should return the Warranty Registration Card to Warrantor. However, return of the Warranty Registration Card is not a precondition of this Warranty. This Warranty will be observed by the Warrantor whether or not the Warranty Registration Card is returned, on the condition that other evidence, satisfactory to Uniden, of the date of the original installation or purchase is provided to the Warrantor.

PROCEDURE FOR OBTAINING PERFORMANCE OF WARRANTY: To obtain warranty service, the Customer must return the radio properly packed, freight prepaid, to Warrantor or any Authorized Warrantor Repair Station. It will be returned freight prepaid.

Technical Support and Service

Your Uniden dealer can provide you with technical assistance and information. If your radio does not perform properly, take it to a Uniden dealer for servicing. The radio contains no user-serviceable parts. Unauthorized adjustment will void the warranty and may cause illegal radio operation. Be sure that a qualified technician services your radio equipment. When servicing the radio, use only factory-authorized replacement parts.

Specifications

Power: Rechargeable Battery Pack (APX1115)

Temperature Range: -30°C to +60°C

Operating Frequencies: **SPU554KTS** 450 MHz to 494 MHz

Nominal Dimensions (with Battery): 2.36" (W) x 1.77" (D) x 5.55" (H)

Weight (with Battery): 1.08 lbs

Duty Cycle: 5, 5, 90 (TX, RX, STDBY) – 8hr (typical)

Contents

Safety Information	2
Introduction	5
Congratulations	5
Description	5
Service	5
Features	6
Programmable Features	6
Unpacking	7
Controls and Functions	8
Getting Started	9
Charging the Battery	9
Attaching/Removing the Battery	9
Installing the Antenna	10
Attaching the Belt Clip	10
General Operation	11
LCD Display	11
Transmit Indicator	11
Applying Power and Setting the Volume	12
Trunking Mode Operation	13
Talk Group Selection	13
Transmit	14
Telephone Operation	14
Receive	15
Scan Operation	15
Scan Lock Out	16
Revert Operation	16
Queueing and Tones	17
TAC Operation	17
Call Function	18
DTMF Keypad Functions	19
Other Functions	21
MENU Operation	21
A/B Quick Keys Operation	22

Conventional Operation	23
Transmit/Receive	23
Transmit Time Out Timer (TOT)	23
Busy Channel Lockout (BCLO)	23
Scan	23
Special Features	24
Back Light	24
Function Tones	24
Using VOX	25
Optional Accessories & Replacement Parts	25
Technical Support and Service	26
Specifications	26
Two-year Limited Warranty	27

TOT Error Tone - a high pitch tone sounding as long as the PTT is held, after TOT has occurred.

Priority Tone - a short high pitch double beep sounding during scan when the Priority Channel is received.

Connect Tone - a Function Enable Tone sounding when system access is achieved.

System Busy Tone - recurring beeps of the DTMF 7 tone pair occurring when access is attempted on a busy system.

Intercept (Out of Range) Tone - Continuous DTMF 7 tone pair occurring after 4 unsuccessful handshake attempts.

Using VOX

The VOX feature automatically switches the radio between the transmit and receive modes when you speak into the microphone. This feature may be programmed into your radio by your Dealer. You must also have the optional headset plugged into the radio.

When you talk, the radio switches to the transmit (talk) mode. When you stop talking, it switches back to the receive mode.

Optional Accessories & Replacement Parts

The following Optional Accessories and Replacement Parts are available from your Uniden Dealer.

- **Rechargeable Battery Pack** (APX1115)
- **Desktop Rapid Charger** (APX140 base and APX140PS adapter)
- **Desktop Standard Charger** (APX141 base and APX141PS adapter)
- **APX155 Charging Cup** (for use with APX140 or APX141)
- **External Microphone with Speaker** (APX 330)
- **Headset** (necessary for VOX operation)
- **Operating Guide** (OM)
- **Antenna** (APX452-6). See your Dealer for exact model

SPECIAL FEATURES

Back Light

When any key except PTT is pressed, keypad and display backlighting is activated and will continue for 5 seconds after the last key press.

Function Tones

The radio is equipped with several tones to indicate error conditions or confirm functions have occurred.

Power On Tone - a high pitch tone indicating the radio has powered up normally.

Malfunction Tone - a long low tone at power on indicating a radio problem. If it persists, return the radio to your Uniden dealer for repair.

Low Battery Tone - two long low tones indicating the battery must be recharged.

Function Enable Tone - a short high tone indicating the key function has been turned on.

Function Disable Tone - two short low tones indicating that the key function has been turned off.

No Function Tone - a low/high/low/high tone sequence indicating the key function is not allowed.

Down-Select Tone - a short low tone occurring at every down-select change.

PTT Error Tone - a low tone sounding as long as the PTT is held, if transmit is not allowed on the selected channel.

BCLO Tone - alternating high/low tones sounding as long as PTT is held if the channel is busy.

TOT Caution Tone - short high pitch beeps sounding every second, beginning 5 seconds before transmitter shutoff occurs.

Introduction

Congratulations

You now own the best value in trunking radio systems, a Uniden professional communications radio. The **SPU554KTS** is an integral part of a trunking radio system which consists of many radio channels with high powered repeater stations that extend range and provide greater access to available channels.

Your **SPU554KTS** Two-Way FM Transceiver offers many special features and can be programmed by your Uniden dealer to provide the features that best meet your needs. Read this Operating Guide completely to be sure you are getting the most from the radio.

Description

The **SPU554KTS** is a trunked/conventional portable Two-Way FM Transceiver. It is microprocessor-controlled, frequency-synthesized, and programmable. It is lightweight, rugged, and fit easily in your hand.

The **SPU554KTS** operates in the 450 to 494 MHz ranges with a maximum RF power output rating of 4 watts.

Service

If your radio does not work properly, take it to a Uniden dealer for servicing. These radios contain no user serviceable parts. Unauthorized adjustments will void the warranty and may cause illegal radio operation. Make sure that a qualified technician services your radio equipment. When servicing these radios, use only factory authorized replacement parts.

Features

- Up to 50 systems
- Up to 100 trunked talk groups or conventional channels
- Carrier squelch and multiple CTCSS/DCS operation
- 10 character Talk group/Channel/Function LCD
- System and group scanning
- Busy system queuing
- Connect tone alert
- Talk-Around-Channel (TAC) operation
- Battery Low Indicator
- DTMF Keypad
- User-Programmable Channel Scan List
- Ten number memory dial

Programmable Features

The operating frequencies and options have been pre-programmed into your radio by your Uniden Dealer. Check with your Dealer for the specific features in your radio.

- Scan Type
- Revert Type
- Scan Dropout Delay
- Transmit Dwell Time
- Transmitter Time Out Times
- Busy Channel Lockout
- Function Tone
- TX Power High/Low
- A/B Quick Key Functions
- VOX Sensitivity and Hang Time

CONVENTIONAL OPERATION

Conventional (non-trunked) channels, if programmed, may be selected in the same manner as described for trunked talk groups. Operation features relative to conventional operation are described below.

Transmit/Receive

1. Select the desired channel with the Up- or Down-select keys, A/B Quick Keys or direct channel select using the numeric keypad.
2. Press the MON/EXIT key to monitor the channel for activity. The LCD will display MONI ON for 2 seconds. If the channel is busy, wait until it is clear.
3. Press the PTT key to transmit. The Red transmit LED will illuminate. For best voice quality when transmitting, hold the unit vertically about one inch from your mouth with the top of the microphone level with your lips.
4. Release the PTT to receive a reply.

Transmit Time Out Timer (TOT)

Continuous transmission time may be limited by programming selection. Five seconds before the time-out, caution beeps will sound every second. After five seconds, transmission will stop and an error tone will sound as long as the PTT is held. When the PTT is released, the TOT is reset.

Busy Channel Lockout (BCLO)

The radio may be programmed to inhibit transmission while a signal is being received. If so, an error tone will sound if PTT is pressed while the channel is busy.

Scan

Scan may be activated by a programmed A/B Quick Key or MENU operation. All channels not locked out will be scanned. Individual channels may be locked out of scan by pressing the L/O button on the desired channel. If scan priority is programmed, receipt of a signal on the first channel in the selected system will cause the Priority Tone to sound. Transmit will always occur on the selected channel during scan operation.

A/B Quick Keys Operation

The A and B Quick Keys can be programmed for any of 9 functions as described below.

- **Talk Group/Channel Recall** - Either or both keys may be programmed with selected talk groups or conventional channels.
- **TAC** - Talkaround operation for the selected talk group or conventional channel may be activated by programming either key.
- **Scan** - Talk group scan or system scan may be activated from either key.
- **Memo Dial** - The memory dial function may be activated to allow recall of stored numbers.
- **Key Lock** - All keys except PTT and EXIT may be locked.
- **Manual Revert** - During scan, the last received talk group may be selected as the active talk group, even if scan has resumed. This allows you to quickly respond to a call even if Last Call Revert or Talkback Revert Scan types are not programmed.
- **Power** - High or low transmit power may be selected. Talk groups programmed for low power cannot be changed to high power.
- **DTMF Redial** - While programmed for any function above except Scan, either key may also be programmed for the secondary function of DTMF Redial as described under DTMF Keypad Functions.

Unpacking

The following should be included with your two-way radio:

- Transceiver Unit
- Antenna
- Belt Clip
- Operating Guide (OM)
- Nickel-Cadmium Rechargeable Battery Pack (APX1115)

If any of these items are missing from the box, contact your Uniden Dealer for help.

FCC Licensing

Before you transmit with your radio, you must have the proper license issued by the Federal Communications Commission (FCC). Your Uniden Dealer can tell you what is required, and can help you with all your future communication needs.

Features, specifications, and availability of optional accessories are all subject to change without notice.

Controls and Functions

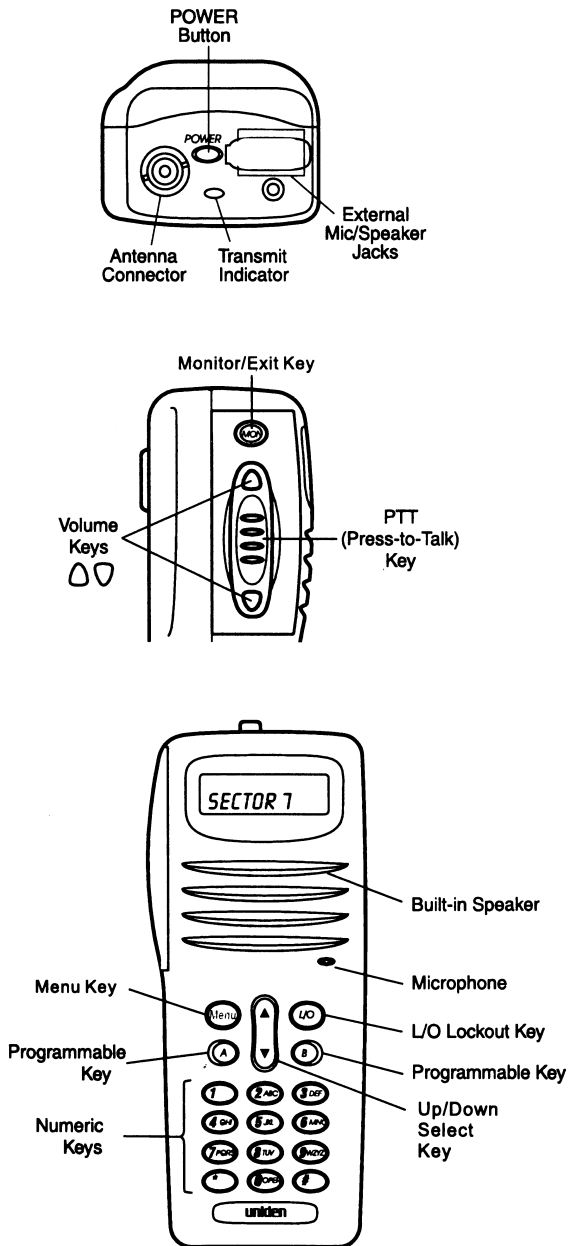

Other Functions

MENU Operation

The MENU key allows accessing menus of up to 7 different functions, if programmed. They are Scan, Memo Dial, TAC, Power, K Tone, K Lock and VOX. Repeatedly pressing the MENU button will sequentially display each of these menu items. When the menu item of interest is displayed, the Up- and Down-select keys can be pressed to make choices within the menu. Menu operation will automatically be exited when the MENU key is pressed to accept the displayed choice, or the MON/EXIT button may be pressed to accept the current choices and return to the selected talk group. The choices within each menu are briefly described below.

- **SCAN** - Off, Talk Group Scan or System Scan may be selected.
- **MEMO DIAL** - Any of 10 pre-stored numbers may be recalled for transmission.
- **TAC** - TAC on or off may be selected.
- **POWER** - High or low transmit power may be selected. Talk groups programmed for low power cannot be changed to high power.
- **K TONE** - Key tone on or off may be selected. When off, all tones related to key functions are disabled.
- **CLOCK** - Key lock on or off may be selected. When off, all keys except PTT and MENU are locked.
- **VOX** - VOX off, low, middle or high may be selected. This selection controls the sensitivity of the VOX function.

the new number for 2 seconds. Additional digits may then be entered by pressing the 0-9, * and # keys.

4. When all digits are entered, press the Up-select button to store the number. The displayed number will flash several times and a single high beep tone will sound to indicate successful storage.
5. To erase a stored number, display it as described above, then press the Down-select key and hold it for 2 seconds. The display will show "BLANK " and a dual low tone beep sequence will sound.
6. Exit the memory storage mode by pressing the MENU or MON/EXIT keys.

Getting Started

Before you can use your radio, you must install and charge the battery and install the antenna as follows.

Charging the Battery

Your radio is powered by a specially-designed, nickel-cadmium battery. You should fully charge the battery before operating the radio. Only use one of the following chargers.

- Model APX140 Desktop Standard Charger
- Model APX141 Desktop Rapid Charger

Follow the charging instructions that come with the charger. Also be sure to observe the following warning/safety information for nickel-cadmium batteries (on the inside front cover of this Operating Guide).

Attaching/Removing the Battery

To attach the battery to the radio, align the slots in the battery with the hooks on the radio as shown. Then, slide the battery toward the top of the radio until it locks into place.

To remove the battery from the radio, push the battery release lever

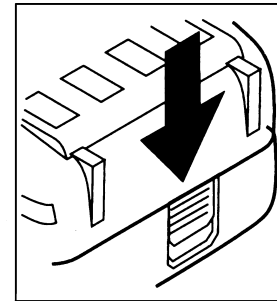

toward the front of the radio and slide the battery toward the bottom of the radio.

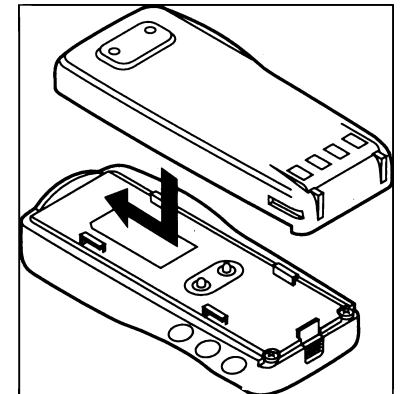

Installing the Antenna

To install the antenna, align it with the antenna connector on the top of the radio and turn it clockwise until it seats snugly against the radio.

Attaching the Belt Clip

Attach the supplied belt clip as shown.

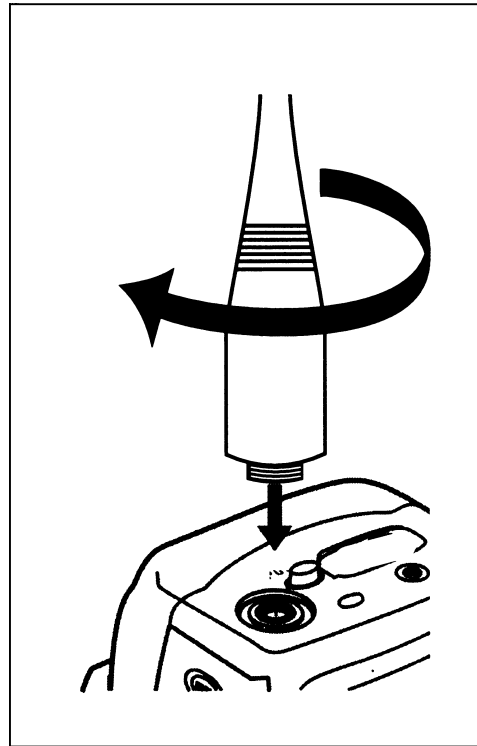
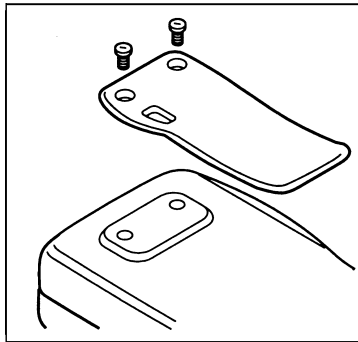

DTMF Keypad Functions

*NOTE: The * and # characters are displayed on the LCD as A and C respectively.*

Manual Dialing - Select an interconnect talk group (indicated by the telephone symbol in the left-most character position of the LCD). Press the PTT to access the repeater, then release to gain the dial tone. Press the PTT again and enter the DTMF digits (DTMF INPUT will be displayed before digits are entered). After the first digit is entered, the PTT may be released without interruption of transmission as long as additional digits are entered within the programmed "hang" time.

DTMF Redial - The A/B quick keys may be programmed to recall the previously entered DTMF digits for redial. To use this function, access dial tone on an interconnect repeater as described above, then press the A or B key and hold for 2 seconds. The last manually entered number will be displayed and can be transmitted by pressing PTT.

Memory Dial - Any of 10 pre-stored memory numbers can be recalled by the A/B quick keys or the MENU operation. Press the A/B key or the Menu key to display MEMO DIAL, then press any of the 0-9 keys to recall the pre-stored number in that location. Press PTT to access dial tone on an interconnect repeater, then press PTT again to transmit the number. Numbers with more than 10 digits will automatically scroll to display the last 10 characters.

Memory Number Storage - Up to ten memory numbers may be stored for recall as follows:

1. Press and hold the MENU button for 2 seconds. The last selected memory location will be displayed, such as "DMEM 0" for memory location 0.
2. Press the 0-9 key to display the number of the desired memory location. Press the same key again to display the stored memory number in that location, if any.
3. While the display shows a stored number or "BLANK", a new number may be entered by pressing and holding the first digit of

TAC ON during the selection process and can be cycled to the opposite mode by pressing the Up- or Down-select key (if accessed by the MENU key) or the A/B key. When active, TAC mode is continuously indicated by the LCD TAC icon.

Call Function

Each talk group may be programmed to flash the MSG icon if a call is received when that group is selected. Also, up to two talk groups may be programmed to display the MSG icon continuously if they are called while selected or while scanned. The MSG icon is turned off by pressing any key.

General Operation

LCD Display

The liquid crystal display (LCD) has 10 characters to designate the selected group or channel by number or name. Above the channel designation area is a row of indicators that show which features are enabled.

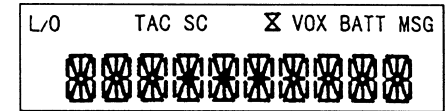

- L/O** Channel removed from Scan List
- TAC** Repeater talkaround is enabled
- SC** Scanning in operation
- X** Unit is in queue
- VOX** Voice-Operated Transmit enabled
- BATT** Blinks when the Battery Power is low
- MSG** Indicates a call has been received

Transmit Indicator

The Transmit Indicator glows RED during transmit.

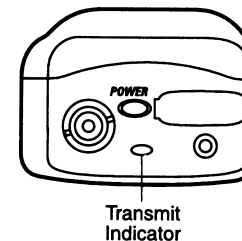

Applying Power and Setting the Volume

1. Turn the radio on by pressing the POWER button to the in position.

The display lights and shows the last-selected talk group/channel designation.

SECTOR 7

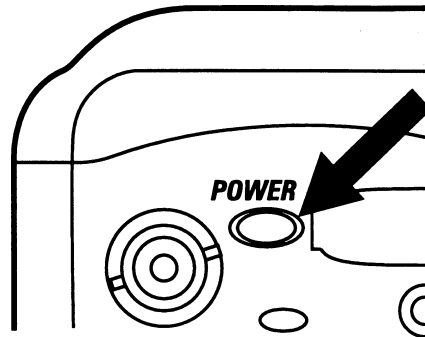

Note: To turn the radio off release the POWER button to the out position.

2. Adjust the speaker volume to a comfortable level by pressing the Volume Up (U) or Volume Down (D) Key. The beep volume at each step gives a relative indication of the volume of the received signal.

Note: If you hold down either of the keys, the volume steps rapidly in the selected direction.

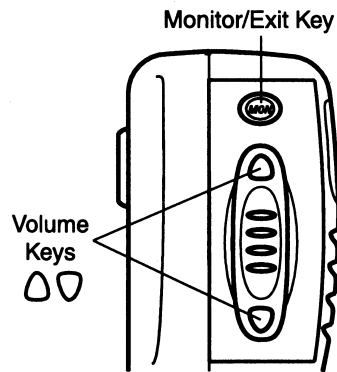

Queueing and Tones

- **Busy System Queueing** - when programmed for queuing and the system is busy when you try to transmit, the radio will automatically enter the queueing mode, indicated by the hourglass display and a high-pitched triple beep. When queued, the radio will monitor the busy system and try every 5 seconds to capture a channel when it becomes available, indicated by a high-pitched double beep sounding every 10 seconds. If the 60 second queueing period elapses without successful system access, a 1 second low tone sounds and the queueing mode is discontinued. If a channel does become available during the queueing period, it is held for 10 seconds, indicated by a single high tone sounding every second. Pressing PTT during the 10 second period will initiate normal operation on the selected talk group. If the PTT is not pressed during this period, the channel is released and the queueing mode is exited.
- **Busy Tone** - if the repeater is in range but busy, you will hear a series of busy tones similar to a telephone busy signal. Release the PTT and try again in a few minutes.
- **Intercept (Out of Range) Tone** - If the radio fails to "handshake" with the repeater after 4 attempts, the intercept tone sounds continuously until PTT is released.
- **Connect Tone** - when programmed for connect tone operation and the radio has successfully accessed the system, a single quick beep alerts you to begin talking.

TAC Operation

To allow direct radio-radio communications in circumstances where both units may not be able to access the repeater, the Talk Around Channel (TAC) mode may be activated. One of the A/B quick keys may be programmed for that purpose or the TAC mode may be accessed from the MENU operation. In either case, the current TAC mode is indicated in the LCD display as TAC OFF or

Scan Lock Out

Individual talk groups or complete systems can be locked out of the scan list at any time.

- **Talk Group Lock Out** - press and release the L/O key to lock out the currently selected talk group. The L/O icon will be displayed to indicate the lockout condition. Press and release the L/O key again to restore the selected talk group to the scan list.
- **System Lock Out** - press and hold the L/O key for 2 seconds on any talk group in the system. The L/O icon will blink when any talk group in that system is selected, regardless of whether that group has been individually locked out. Press and release the L/O key on any talk group in a locked out system to restore the system to the scan list.

Revert Operation

During scan operation, the active talk group selection may change depending on the revert programming.

- **Last Talk Group Revert** - the received talk group becomes the active talk group.
- **Talkback Revert** - the received talk group becomes the active talk group only if the PTT is pressed during the dropout delay time (period before scan resumes).
- **No Revert** - the selected talk group is always active regardless of what other talk groups are received. To answer a call on another talk group, use the Up- or Down-select keys to display the received talk group, then press the PTT.

Trunking Mode Operation

Talk Group Selection

1. **Up/Down Select**- Press the Up/Down key (▲ or ▼) to display the desired talk group. An up-select or down-select tone sounds with each change. If you press and hold either key, the radio changes talk groups rapidly.



(If programmed with a "stop", talk group changes will stop when the highest or lowest talk group number has been reached.)

2. **A/B Key Selection** - Either or both of the A and B keys may be programmed for instant selection of a pre-programmed talk group. Press the programmed key to instantly select the programmed talk group.
3. **Direct Talk group Selection** - The numeric keypad 0-9 keys may be used to directly select the desired talk group. Press one or two digits and the Up-select key (▲) to select a talk group. For example, press 4, 7 and (▲) to select talk group 47. If the (▲) key is not pressed within 5 seconds after pressing the digit keys, the entered digits will be ignored. During the 5 second period, the (▼) key may be used to clear the entered digits from the display.
4. **Direct System Selection** - The numeric keypad 0-9 keys may be alternatively programmed to make system selections instead of talk group selections. If programmed for such operation, the lowest numbered talk group in the selected system will be displayed. Use the Up- or Down-select keys to select the desired talk group within the system.

Transmit

1. Select the desired talk group as indicated above.
2. Press the PTT key on the side of the unit. Keep the PTT button depressed while you transmit your message. Notice that the red TX indicator flashes at least twice while the radio "handshakes" with the repeater system. Delay speaking until the TX light is steady. If the Connect Tone is programmed, just wait for it to sound, then begin talking. If transmission is difficult, try to find a higher location with fewer obstructions between you and the repeater site. Release the PTT key when your message is finished.
3. For best voice quality when transmitting, hold the unit vertically about one inch from your mouth with the top of the microphone level with your lips.

Telephone operation

1. Select a talk group allowing telephone access, indicated by the telephone symbol at the left-most end of the display.
2. Press the PTT to access the system, then release to gain dial tone.
3. Transmit the number manually entered or recalled as described under DTMF Keypad Functions.
4. If someone answers, key the transmitter to talk and release to listen.
5. When transmission is complete, "hang up" the connection by pressing the # button on the keypad or the MON/EXIT button.

Receive

Select the talk group you want to receive as indicated above. Scan operation may be activated as described below to automatically monitor a number of talk groups.

Scan Operation

In the scan mode, the radio monitors each talk group in the selected system or all systems until it receives a call. You can scan all talk groups/systems, or you can lock out individual talk a groups/systems from being scanned.

1. Scan operation may be activated through the MENU operation or one of the A/B keys may be programmed for that purpose.
 - **MENU Scan Activation** - press and release the MENU key to display the current scan condition. Press the Up- or Down-select keys to select the desired condition (SCAN OFF, SCAN GRP or SCAN SYS). The LCD SC indicator will be displayed continuously when talk group scan is active and blink when system scan is selected. Exit menu operation by pressing the MENU or MON/EXIT keys.
 - **A/B Key Scan Activation** - press and release the A or B key to activate scan of all talk groups in the selected system. The LCD SC indicator will be displayed to indicate talk group scan. Press and hold the key for 2 seconds to activate scan of all systems, indicated by the flashing SC icon. To deactivate either talk group or system scan operation, press and release the A or B key.
2. If scan priority is programmed, receipt of the priority talk group (first talk group in the selected system) will be accompanied by sounding of the Priority Tone. After the first group, the order of priority is group 2, the selected group, then the balance of the groups in the selected system in the programmed order.

